

ROASTER 

MANUAL

ROASTER OVEN

By BIOKAN Inc.



**PLEASE READ ALL THE INSTRUCTIONS IN
THIS MANUAL THOROUGHLY BEFORE
INSTALLING AND OPERATING THE OVEN.
RETAIN IT FOR FUTURE REFERENCE.**

IMPORTANT

The present manual will help you use the product safely.

- Read all instructions before installing and using the equipment.
- Save these instructions.
- Keep the manual within reach for future reference.
- The pictures, technical drawings and general information in this manual might have been modified since its first edition.

When this oven is not properly installed, a fire may result. To reduce risk of fire, follow the installation instructions.

Please read this manual carefully before you install the oven.

Failure to follow instructions may result in property damage, body injury or death.

ROASTER 

BIOKAN

Since 1988

KOZANI, GREECE

WELCOME TO ROASTER by BIOKAN Inc.

Our company, BIOKAN Inc. was founded in 1988 and is headquartered in Kozani, Greece. Since then, we have been manufacturing stainless steel constructions for restaurants and other food service establishments.

Over the past few years, we have specialized in manufacturing commercial kitchen exhaust hoods, charcoal ovens and rotisseries with great success. What led us to this success is the know-how and our experienced staff as well as our avant-garde machinery. We boast one of the most technologically advanced production lines of stainless-steel constructions in Greece.

As a result, we manufacture high quality products, which combine modern design with functionality, to the most competitive prices.

We manufacture and offer to our clients a large product line of stainless-steel commercial kitchen equipment, such as exhaust hoods, charcoal ovens, wood/gas pizza ovens, charcoal rotisseries and grills. We also offer consulting services, regarding the exhaust hood installation and the space disposal of the professional equipment in commercial kitchens.

BIOKAN believes in continuous improvement. Our engineers are constantly developing and redesigning products so that they can respond to our customers' needs. BIOKAN strives to construct products that are more efficient, easier to install and maintain, and products that meet the highest standards.

Our Vision is to continue being a customer centric business which has determined our development, commercial expansion, and strategy since our foundation and to keep providing our clients with high quality products and services to fair prices.

As a result, we have established long-term and fruitful business relations with the companies we have cooperated for the past few years. We always offer to our clients the best pre-sales and after - sales support.

As a result, we have established long-term and fruitful business relations with the companies we have cooperated for the past few years.

CONTENTS

1. BEFORE USING THE OVEN

1.1 Before using the oven.....	5
--------------------------------	---

2. ROASTER OVEN MODELS

2.1 Roaster Oven Models	8
-------------------------------	---

2.2 Roaster Oven Technical Information	9
--	---

2.3 Drawings	11
--------------------	----

3. COMPONENTS

3.1 Components	12
----------------------	----

3.2 External Components	13
-------------------------------	----

3.3 Internal Components	15
-------------------------------	----

4. USE INSTRUCTIONS

4.1 Warnings	16
--------------------	----

4.2 How to fire up the oven	17
-----------------------------------	----

4.3 How to reload/Put out the oven	18
--	----

5. CLEANING AND MAINTENANCE

5.1 Warnings	19
--------------------	----

5.2 Cleaning.....	20
-------------------	----

5.3 Maintenance	21
-----------------------	----

6.3.1 Instructions	22
--------------------------	----

7. WARRANTY

7.1 Warranty	23
--------------------	----

8. CONTACT DETAILS

8.1 Contact	24
-------------------	----

1.1 BEFORE USING THE OVEN



Place the oven on a hard level, non-combustible, stable surface (concrete, ground, etc.), which can support the weight of the oven. Never place the oven on wooden or other combustible surfaces.



The oven is hot when in use. To avoid burns wear protective gloves or oven mitts.



DO NOT touch any surface of the oven, as the surfaces are at high temperature.



DO NOT attempt to move the oven when it is in use. Do NOT clean the oven while it is still hot.



Place the oven on a surface which is NOT accessible to children and pets. Close supervision is necessary when the oven is in use.



Never leave burning charcoal or ashes in the oven unattended. Before the oven can be left unattended, the remaining charcoal and the ashes must be removed. Do NOT pour ashes into flammable or thermo deformable buckets made from materials like plastic, rubber, wood or similar.

1.1 BEFORE USING THE OVEN



Store the unit in a safe and dry place. Rain or adverse weather conditions may damage the oven.



Do NOT put off the fire by throwing water in the oven.



Do NOT throw the charcoal into the oven but place them gently.



DO NOT store lighter fluid and other flammable liquids or materials under the oven. Put any flammable material at least 30 cm away from the sides or the top of the oven.



DO NOT use gasoline, kerosene or alcohol to fire up the charcoal. Using any of these or similar products could cause an explosion and possibly lead to severe injury.



DO NOT install this appliance in any area where it may be affected by any adverse conditions such as steam, grease, dripping water, high temperatures, or any other adverse conditions.

1.1 BEFORE USING THE OVEN



Respect the frequency and guidelines of maintenance and cleaning recommended by Roaster in this manual.



When this equipment is not properly installed, a fire may result. To reduce risk of fire, follow the installation instructions.



Roaster will not be responsible of any damages caused to people, parts or installations due to improper use or maintenance of the oven.



The legislation of the country and town, where the equipment is going to be installed, must be checked since norms and regulations may ask for further safety measures than the ones exposed in this manual.



The oven must always run with the door closed.

2.1 ROASTER OVEN MODELS



Roaster 54	Roaster 56	Roaster 74	Roaster 76	Roaster 96
45 diners	75 diners	75 diners	110 diners	160 diners



2.2 ROASTER OVEN TECHNICAL INFORMATION

ROASTER 54

Productivity + -	45 diners
Fire up time	30 min average
Charcoal daily consumption	6 – 8 kg
Broiling temperature	250 °C to 350 °C
Exhaust rate	1.600 m3/h
Net weight	175 kg

ROASTER 56

Productivity + -	75 diners
Fire up time	30 min average
Charcoal daily consumption	10 – 12 kg
Broiling temperature	250 °C to 350 °C
Exhaust rate	2.100 m3/h
Net weight	200 kg

ROASTER 74

Productivity + -	75 diners
Fire up time	30 min average
Charcoal daily consumption	10 – 12 kg
Broiling temperature	250 °C to 350 °C
Exhaust rate	2.100 m3/h
Net weight	200 kg

ROASTER 76

Productivity + -	110 diners
Fire up time	30 min average
Charcoal daily consumption	15 – 17 kg
Broiling temperature	250 °C to 350 °C
Exhaust rate	2.500 m3/h
Net weight	280 kg

ROASTER 96

Productivity + -	160 diners
Fire up time	30 min average
Charcoal daily consumption	17 – 20 kg
Broiling temperature	250 °C to 350 °C
Exhaust rate	2.700 m3/h
Net weight	305 kg

2.2 ROASTER TECHNICAL INFORMATION

INSTALLATION

Clearance with non-flammable equipment	100 mm
Clearance with flammable equipment	300 mm

INCLUDED ACCESSORIES

2 Stainless steel grill racks

Upper heating rack

Chimney kit

Ash pan drawer

2 Stainless steel tongs

Grease tray

Grill scraper

Poker

Ash shovel

OPTIONAL ACCESORIES

Cabinet

Table

Extra grill rack

Extra tong

Extra grill scraper

Extra poker

Extra ash shovel

SPARE PARTS

Thermometer

Spring

2.3 DRAWINGS

DIMENSIONS:



	ROASTER 54	ROASTER 74	ROASTER 54	ROASTER 74	ROASTER 96
X	765	965	765	965	1165
Y	580	580	780	780	780
Y1	510	510	710	710	710
Y2	850	850	1050	1050	1050
Z	1270	1270	1270	1270	1270
Z1	800	800	800	800	800
Z2	470	470	470	470	470

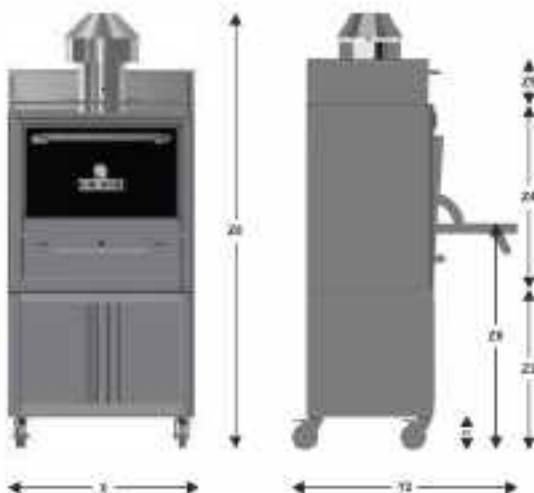

	ROASTER 54	ROASTER 74	ROASTER 54	ROASTER 74	ROASTER 96
X	765	965	765	965	1165
Y2	850	850	1050	1050	1050
Z3	635	635	635	635	635
Z4	750	750	750	750	750
Z5	180	180	180	180	180
Z6	900	900	900	900	900
Z7	120	120	120	120	120
Z8	1910	1910	1910	1910	1910

CE



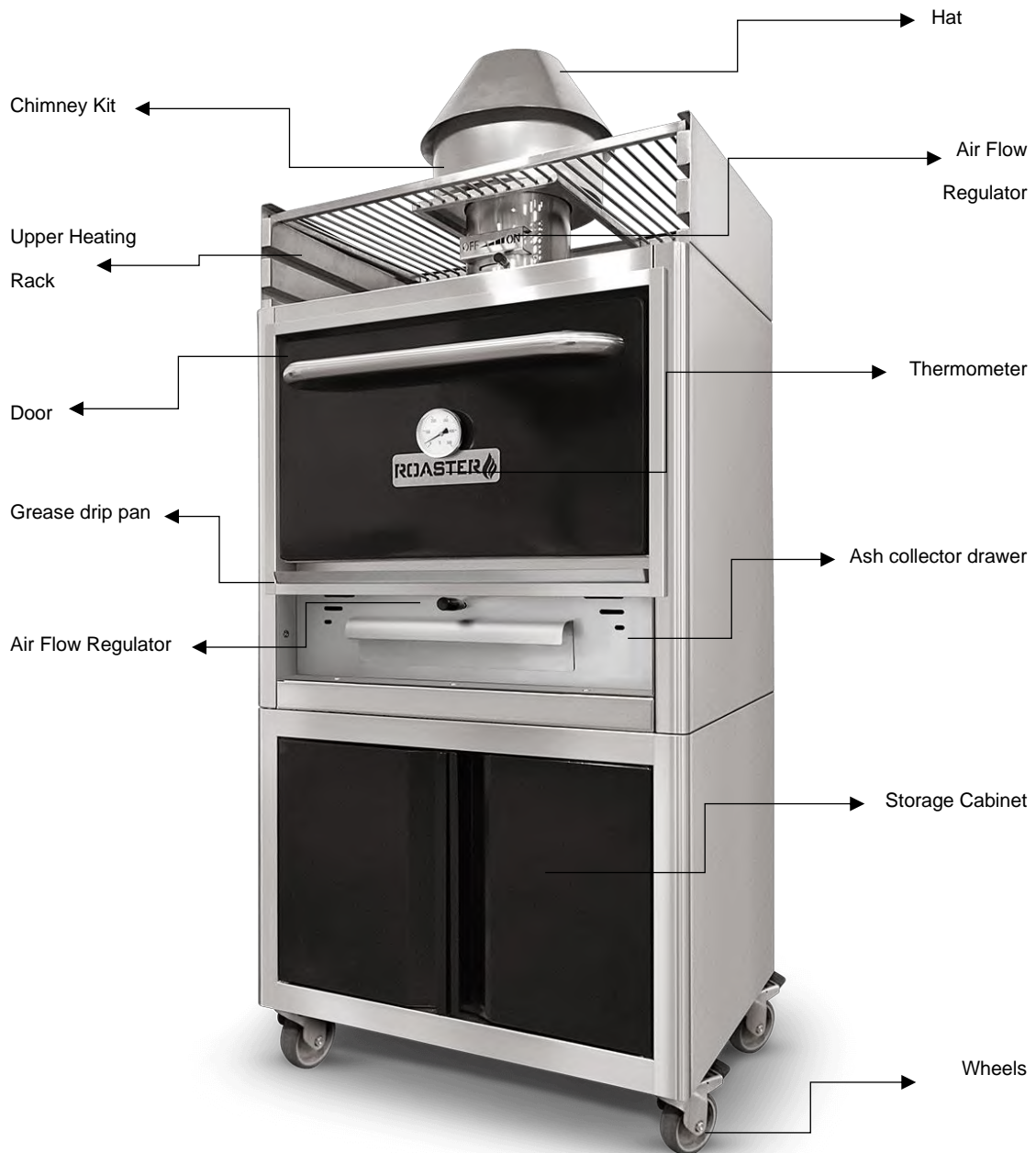



3.1 COMPONENTS







3.2 EXTERNAL COMPONENTS

	DESCRIPTION	MODEL
	Thermometer up to 500°	CT2
	Fire breaker with air flow regulator	RAF
	Wheels	CGA12
	Door Handle	RDH1
	Upper Heating Rack	RAH 54 RAH 56 RAH 74 RAH 76 RAH 96

3.2 EXTERNAL COMPONENTS

	DESCRIPTION	MODEL
	Removable Inox Grease Drip Pan	RGP1
	Storage Cabinet	RAC 54 RAC 56 RAC 74 RAC 76 RAC 96
	Table	RAT 54 RAT 56 RAT 74 RAT 76 RAT 96
	Door	RD1
	Poker	POK
	Tong	RATN

3.3 INTERNAL COMPONENTS

	DESCRIPTION	MODEL
	Fire grate	RFG1
	Stainless steel grill rack	RAG 54 RAG 56 RAG 74 RAG 76 RAG 96
	Ash collector drawer	RACD1
	Door spring	RDS1
	Ash damper	RASHD1

4.1 WARNINGS



Before fire-up the oven for the first time, remember to remove all the plastics that are covering the exterior of the oven.



This product may have been dispatched in more than one packages. Check that all items and accessories have been received as ordered. Keep all instructions/manuals.



Do NOT use flammable liquids to fire-up the charcoal. Only use charcoal as fuel for the oven.



DO NOT place any obstructions that may block the access for the maintenance or the service of the oven. DO NOT block the lateral and inferior part of the oven. DO NOT modify or damage the legs or the wheels of the oven.



Always place the oven under an exhaust hood.



In all the installation options, it is important to keep the components of the oven clean (see Chapter 5, Cleaning and maintenance).



The diameter of the extraction tube must be at least 300 mm for all the models.



You must fire-up the oven before starting roasting. All the firing-up process must be done without any accessories inside the oven.



Place the oven at a distance of at least 100 mm away from the wall or any other cooking appliance.

4.2 HOW TO FIRE UP THE OVEN

INSTRUCTIONS:

- Use solid charcoal fuel only.
- Do NOT place the charcoal inside the drawer.
- Open the air flow regulator of the chimney prior to the loading of the charcoal.
- Open the oven door and remove the grill racks in order to free space for the charcoal.
- The quantity of charcoal required depends on which ROASTER oven model you are using.

Model	ROASTER 54	ROASTER 56	ROASTER 74	ROASTER 76	ROASTER 96
Maximum quantity	4 kg*	5 kg*	5 kg*	6 kg*	6,5 kg*
kW equivalence	2	3,5	3,5	5	6

**The charcoal or briquette quantity you are going to use depends on the charcoal or briquette quality.*

- Open the lower and the upper air regulator to the maximum.
- Place the charcoal in the middle of the oven by forming a pyramidal shape, set them on fire (at least at 3 different spots) and close the door.
- Wait for at least 35 minutes until the charcoal has totally turned into embers. Then, close the lower air regulator, and wait 10 minutes leaving the upper air regulator open.
- When you do not see any black charcoal, flatten and distribute the burning charcoal evenly.
- Place the grill racks inside the oven, as the oven is ready to operate.
- The lower air regulator should remain closed, the upper air regulator opened approx. by 50%.
- During the cooking, open the upper air regulator to the maximum if a lot of smoke is coming out of the oven. The upper air regulator should remain open to the maximum, until the smoke disappears.
- You may also maintain steady the temperature by adjusting the upper regulator.

4.3 HOW TO RELOAD/PUT OUT THE OVEN

INSTRUCTIONS to RELOAD THE OVEN:

- Open the door and remove the grill racks.
- Open the lower and the upper air regulator to the maximum.
- Stir with caution the existing burning charcoal.
- Add the necessary amount of charcoal. This depends on the amount of charcoal used before.
- Close the door and follow the above-mentioned steps before cooking.

INSTRUCTIONS TO PUT OUT THE OVEN:

- At the end of the cooking close the upper air regulator of the oven and make sure that the lower regulator and the door are closed.



Do not put out the oven by using water or other liquids.

Charcoal will be consumed itself.

- Close the door of the oven and wait for 30 minutes.
- When the oven has been completely put out, remove the ashes with caution.
- If there is charcoal left in the oven it can be used for the next service.

5.1 WARNINGS



Perform the operations when the oven is cold to avoid burns.



Do NOT use chemical products to clean the oven.



Prior to maintenance or cleaning of the oven, any object or ash from the previous service should be removed. Do NOT pour ashes into flammable or thermo deformable recipients made from materials like plastic, rubber, wood or similar.



DO NOT splash water directly into the oven and DO NOT use any water or any kind of liquid.



Clean with e grease remover and a cloth or a brush.

5.2 CLEANING

- Remove the ash from the oven when it is cold after every use.
- It is necessary to clean the grill racks and the other roasting accessories after every use. Clean well the door frame, especially where grease from cooking accumulates most with a brush.
- Remove the grease tray and wash it with a grease remover and a brush or cloth.
- Do NOT use a corrosive grease remover to clean the outside of the oven or/and the inside of the cabinet below.
- Clean the door of the oven with a grease remover and a cloth.
- Take the grill racks out of the oven carefully and clean them with a wire brush. This must be done before cooking to clean the grease accumulated from the previous use.
- Remove the ash drawer and clean it with a grease remover and a brush.
CAUTION! Ashes must be placed in a metal container which should be placed on a non-combustible surface or on the ground, away from combustible materials, until their final disposal.
- Clean weekly the fire breaker hat. Remove the hat, turn it upside down and hit it with a wooden or plastic spatula. The soot removal will avoid blocking the smoke exhaust. The hat can be washed with grease remover and a wet cloth.
CAUTION! Do NOT use water or other liquids to clean the inside of the firebreaker.
- The fire grates should be cleaned twice a month with a wire brush. Change the position of the fire grates every time you clean them, putting the ones of the middle to the sides, and the ones of the sides in the middle.
CAUTION! DO NOT use water.

5.3 MAINTENANCE



Make sure that the oven is cold before performing any maintenance operation.



Wear protective gloves or oven mitts.



It is forbidden to perform any modification to the equipment unless it has been approved by Roaster before.



Do NOT use pieces or parts of other companies.



Roaster will not be responsible of damages provoked to people, parts or installations caused by an improper use or maintenance of the oven.



All inspections must be carried out by qualified personnel.

5.3.1 INSTRUCTIONS

- **Thermometer replacement.**

Put on protective gloves.

Unscrew the screw, twisting it with an anticlockwise direction and remove the thermometer.

Put the new thermometer in place and make sure that it is set straight.

Screw the bolt back in place.

- **Spring Replacement**

Put on protective gloves.

Unscrew the bolts laterally to have access to the door opening mechanism.

Pull the housing gently and remove it.

Unscrew the bolts at the two edges of the old spring. Remove the old spring and replace it with the new one by fastening the bolts at the edges again.

Make sure that the door closes smoothly before putting back the housing otherwise regulate the bolts.

Perform the same actions on the other side of the oven.

- **Grease the chain twice a year.**

Put on protective gloves.

Unscrew the bolts laterally to have access to the door opening system.

Pull the housing gently and remove it.

Grease the chain with a special temperature grease.

6.1 WARRANTY



ROASTER guarantees ONE-year warranty from the purchase date of this product, against any defect in the materials and the components used during its fabrication.

THIS WARRANTY WILL NOT BE VALID UNDER THE FOLLOWING CIRCUMSTANCES

1. When the Buyer or the End user do not follow strictly the instructions of use in this manual.
2. When the product has been misused, damaged or exposed to any liquid or corrosive substance or for any other faults attributable to the Buyer or End user.
3. When the product has been modified or repaired by non-qualified personnel.
4. When the fault is due to the normal wearing out of the rotisserie and its parts due to long term use.
5. When the damage is caused by liquids, chemicals or products that should not be poured inside the oven.

NOTES:

- Repair or substitution is possible only when a product was originally defective (at the time of delivery).
- The Buyer or the End user is responsible for any damage caused due to wrong or improper use.
- The Buyer should inspect the products immediately after the delivery and any complaints or arguments must be sent to our company within five (5) business days.
- The risk of loss, destruction, or damage of the product during the shipping is the Buyer's or carrier's responsibility, even if the shipping order has been given by our Company upon the Buyer's request.
- All repairs during the warranty periods of 12 months, are performed in our factory in Greece.
- The Buyer is responsible for the shipping of the products and covers exclusively the shipping cost.
- If the problem to be repaired is caused by an incorrect use or installation a charge will be applied, even if the product is in the warranty period.

No other warranty, verbal or written, different than the one expressed here will be accepted by Roaster.



CHARCOAL OVENS & GRILLS

By BIOKAN Inc.



www.biokan.gr



sales@biokan.gr



www.facebook.com/RoasterOvens



https://www.instagram.com/roaster_ovens



<https://www.linkedin.com/company/biokan-oe>



<https://www.youtube.com/channel/UCjOpxGWZamP7FVeQ2Dx45yA>

FACTORY

2nd km. Kozanis – Neas Nikopolis, 50100, Kozani, GREECE

Tel.: +30 2461 0 36538

HEAD OFFICES

312 Syggrou Av, Kallithea, 17673, Athens, GREECE

Tel.: +30 21 0 2203458